

TECHNICAL DATA SHEET  
**CPA 12**  
**Illuminated Magnetic Frame**

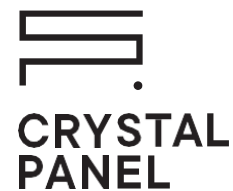

- 01 / CONFIGURATION OF THE LIGHT**
- 02 / ELECTRICAL PARAMETERS**
- 03 / TECHNOLOGY, MATERIALS TO BE APPLIED AND DISTANCES**
- 04 / INSTRUCTIONS CONCERNING INSTALLATION**
- 05 / DURABILITY AND LIMITATIONS OF APPLICATION**
- 06 / LIGHT DIFFUSING MATERIALS**
- 07 / BEFORE PLACING THE ORDER**
- 08 / INFORMATION CONCERNING THE USAGE AND WARNINGS**
- 09 / FINAL REMARKS**

SKL PLUS SP. Z O.O.  
ul. Błażeja 70D / 61-608 Poznań, Poland  
VAT No. / VAT ID: PL9721195168 / REG: 301067675 / KRS: 0000334391  
[export@crystal-panel.com](mailto:export@crystal-panel.com) / phone: +48 61 622 94 64 / [www.crystal-panel.com](http://www.crystal-panel.com)



# TECHNICAL DATA SHEET

## CPA 12

### Illuminated Magnetic Frame

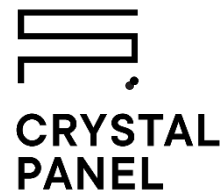

#### 01 / CONFIGURATION OF THE LIGHT

**a. Illuminated edges:**

- depending on the expected light effect and panel size: one (UNO), two (DUO)
- UNO backlighting can be implemented up to a maximum length of 600 mm light path

**b. Standard colour temperature:**

- 3 000K, 4 000K, 5 000K, 6 500K.
- Other colour temperatures are available upon the Customer's request
- RGB / RGBW / Multi White strips are not available

**c. Standard for 12V installations:** a flexible LED strip with an output power of 17W/running meter, SMD 2835 LEDs, 102 crystals/running meter, and module length of 29.6 mm

**a. For 24V installations, we are using:** a flexible LED strip with an output power of 21W/running meter, SMD 2835 LEDs, 100 crystals/running meter, and module length of 59.2 mm

#### 02 / ELECTRICAL PARAMETERS

**a. Voltage supply:**

- Standard: 12V / 24V

**b. Power supply type:** we recommend MeanWell impulse power supply

**c. Temperature of panel during work measured on the radiator:**

- 38-40 °C - may vary depending on when the product is placed and the method of installation

**d. Current consumption:**

- 12V: 1.4 A/running meter LED strip
- 24V: 0.9 A/running meter LED strip

**e. Power Consumption:**

- 12V: 17W/running meter LED strip
- 24V: 21W/running meter LED strip

**f. CRI/RA:**

- Standard: >85
- Upon the Customer's request: >90 and >97 possible

**g. Controllers:**

- Dimmers, interrupters and other diode controllers suitable for constant voltage supply of 12 and 24V respectively.

CP-KP-CPA-12\_07\_2024



# TECHNICAL DATA SHEET

## CPA 12 Illuminated Magnetic Frame

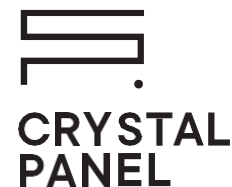









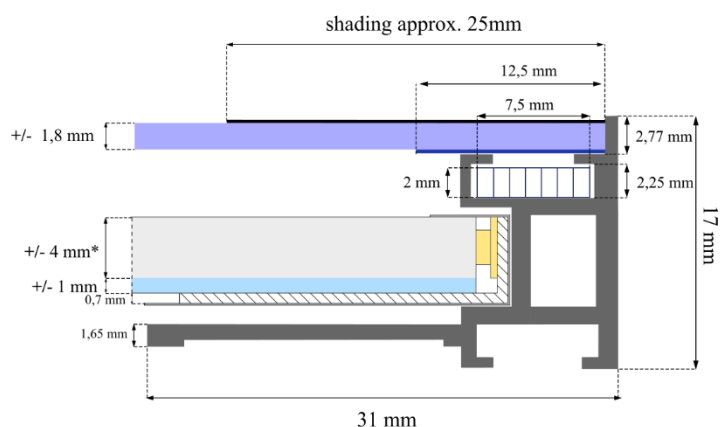

### 03 / TECHNOLOGY, MATERIALS AND DISTANCES

#### a. CPA 12 components:

- Underframe: aluminum profile CPA 12
- Illumination component: Crystal Panel LED
  - Engraved PMMA plexiglass sheet
  - HIPS - rigid reflective sheet
  - Adhesive reflective tape – PP on aluminium base, acrylic adhesive
  - Radiator in the form of a thin-walled L-shaped profile, made of anodized aluminum
  - Flexible, constant voltage LED strip with a cord
- PMMA XT 1.8mm transparent acrylic with a 25mm wide black adhesive tape frame affixed in place.
- Fittings for CPA 12: corners
- neodymium magnet
- steel tape

### TECHNICAL CROSS SECTION CPA 12



	ALUMINIUM PROFILE CPA 12		HIPS 1 mm
	NEODYMIUM MAGNET		PLEXI PMMA XT
	REFLECTIVE TAPE		LED STRIPE 4 mm
	RADIATOR		PLEXI PMMA GS*
	STEEL TAPE		

\* Material tolerance total +/-20%

CP-KP-CPA-12\_07\_2024



# TECHNICAL DATA SHEET

## CPA 12 Illuminated Magnetic Frame

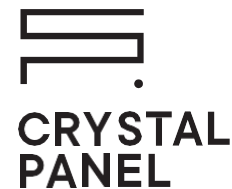

b. Plexiglass thickness: 4 mm

c. Applied materials: PMMA, PVC, aluminium, polypropylene, high-impact polystyrene

d. Engraving pattern: dots

e. Frame weight: 10 kg/m<sup>2</sup>

f. Possible maximum frame size: 1000 x 800 mm - with structural reinforcement

g. LED module length:

- LED 12V: 29.6 mm
- LED 24 V: 59.2 mm

h. Length of the illuminated edge:

In order for the surface to be evenly illuminated, the total length of the illuminated consists of multiplication of the LED module length and the tolerance for making the solder connection (5 mm)

i. Length of the power cord

- In case of the standard orders: we install SMYp 2x0.35 black cords, 1.5 m long, - exit at the back
- Upon customer's request: Other lengths of power cord are available (above the standard for an additional fee) and after agreement with the Consultant, considering the voltage drops, and for additional fee.

j. Dimensional tolerance:

- Frame size in tolerance: -2 mm from the nominal size

### 04 / INSTRUCTIONS CONCERNING INSTALLATION

---

a. Recommended method of installation

- On mounting pins
- Directly in a properly shaped piece of furniture or other structure
- Using other support or shaped brackets
- Using the PEM installation system
- With the help of pendants (hooks)

The aforementioned methods or other non-standard methods of installation have to be determined with our Consultant as they can affect the selection of materials to be used, the production process or the method of securing particular elements of the product.

CP-KP-CPA-12\_07\_2024



# TECHNICAL DATA SHEET

## CPA 12 Illuminated Magnetic Frame

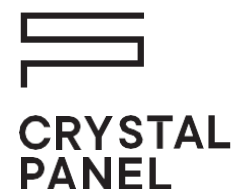

### 05 / DURABILITY AND LIMITATIONS OF APPLICATION

---

**a. Expected diode life span:**

- Minimum 50.000h (with a proper power supply and at optimum operating temperature)

**b. Optimum working temperature range:**

- 10 to 25 °C (in a condensation-free environment)

**c. Protection class: IP40**

LED panel cannot be exposed to direct contact with water. Indoor use only.

### 06 / LIGHT DIFFUSING MATERIALS

---

**a. Standard material for illumination:**

- backlit foil
- plexiglass print

### 07 / BEFORE PLACING THE ORDER

---

**a. Measurements:**

- Remember that the external dimensions of the frame are not the same as the dimensions of the illuminating surface!
- Indications as to the size of printouts and backlit materials can be found in the Standard of Production
- When designing the holes and their location, consider the thermal expansion of the PMMA
- Plan space for the power cable coming out of the panel

**b. Placement of the power supply:**

- Find the proper place to install the power supply to provide its proper cooling and availability in case of malfunction
- The cord length from the power supply to the panel should not exceed 2.5 m due to voltage drops. In special cases, when the cord will have to be longer, please contact the Consultant - he will find the right solution in each case!

CP-KP-CPA-12\_07\_2024



# TECHNICAL DATA SHEET

## CPA 12 Illuminated Magnetic Frame

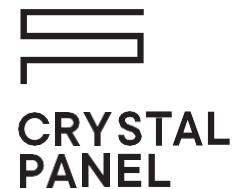

### 08 / INFORMATION CONCERNING THE USAGE AND WARNINGS

---

#### a. It is recommended to:

- Store and transport the panel in the original packaging, possibly in vertical position, carry it like the sheet of glass
- Avoid unnecessary loads on the illuminated edges (especially heat and impact loads), pay special attention to the places where the cables exit.
- Remove the protective foil from the antireflective ONLY during the final stage of installation
- Clean the antireflective surface using a window cleaner with low alcohol content (such as Clin Anti-Fog) and with a soft cloth or paper towel
- Protect the edges with LEDs from accidental damage or ripping off the power cord
- Pay particular attention to the power supply voltage, make sure that the power cord of the panel is not connected to 230V mains

#### b. It is not allowed to:

- Stick the graphics, adhesive tapes, foils and other materials directly on the panel surface
- Overload the frame
- Pull by the cord
- Place the frame into the water
- Mount the frame by gluing its back surface to the substrate (wall)

### 09 / FINAL REMARKS

---

a. Any modifications made without the written consent of the Producer will void the warranty.

b. In case of any doubts concerning the application of our products, we encourage you to contact Crystal Panel Consultants.

CP-KP-CPA-12\_07\_2024

